



VS0605U

**6 CHANNEL MULTI-FORMAT
STREAMING VIDEO SWITCHER**

Contents

1. Brief Introduction.....	1
1.1 Overview.....	1
1.2 Main Features.....	1
2. Connections.....	2
2.1 Interfaces.....	2
2.2 Specification.....	3
3. Control Panel.....	6
3.1 Description.....	6
3.2 Keyboard Button.....	7
4. Operation Instrubtion.....	10
4.1 Multiview Output Layout.....	10
4.2 T-Bar Calibration.....	11
4.3 PGM & PVW Switching.....	11
4.3.1 PGM & PVW Channel Selection.....	11
4.3.2 Transition Control.....	12
4.3.3 FTB (Fade to Black).....	12
4.3.4 Source Selection of Channel 5 and Channel 6.....	12
4.3.5 USB Media Player.....	13
4.4 Transition Effects.....	14
4.4.1 MIX Transition.....	14
4.4.2 WIPE Transition.....	14
4.4.3 FADE Transition.....	14
4.5 PIP and POP.....	15
4.6 Chroma Key.....	16
4.7 Luma Key.....	16
4.8 USB3.0 Live Streaming.....	17
5. PTZ Camera Remote Control.....	17
5.1 Camera Setting.....	17
5.2 RS-422/RS-485 Interface Define.....	18
6. Menu Settings.....	18

6.1 Status Menu.....	18
6.1.1 Audio Settings.....	18
6.1.2 Output Format Setting.....	19
6.2 Main Menu.....	19
6.2.1 System Settings.....	20
6.2.2 Network Settings.....	20
6.2.3 Record Settings.....	20
6.2.4 TSL Settings.....	21
6.2.5 Tally Port Define.....	21
6.2.6 Device Info.....	22

1. Brief Introduction

1.1 Overview

The video switcher is an all-in-one 6-channel video switcher that allows video switching, audio mixing, and video recording.



1.2 Main Features

- Uncompressed capture for live streaming, comply with UVC & UAC
- 6 channel inputs: 4xSDI and 2xDVI-I/HDMI/VGA/USB player inputs
- 2xSDI & 1xHDMI PGM outputs, 1xSDI AUX output, 1×USB type-C out
- 1xSDI & 1xHDMI multiview outputs
- Input format auto-detected and PGM/AUX output format selectable
- Remote PTZ camera control: Visca & Pelco protocol
- T-Bar/ AUTO/ CUT transitions and MIX/ FADE/ WIPE effects
- Luma Key/ Chroma Key for virtual studio
- PIP/ POP window size and position adjustable
- Record PGM video to SD card, up to 1080p60
- Audio mixer: TRS audio & SDI, HDMI, USB embedded audio
- Tally port for multiple camera system

2. Connections

2.1 Interfaces

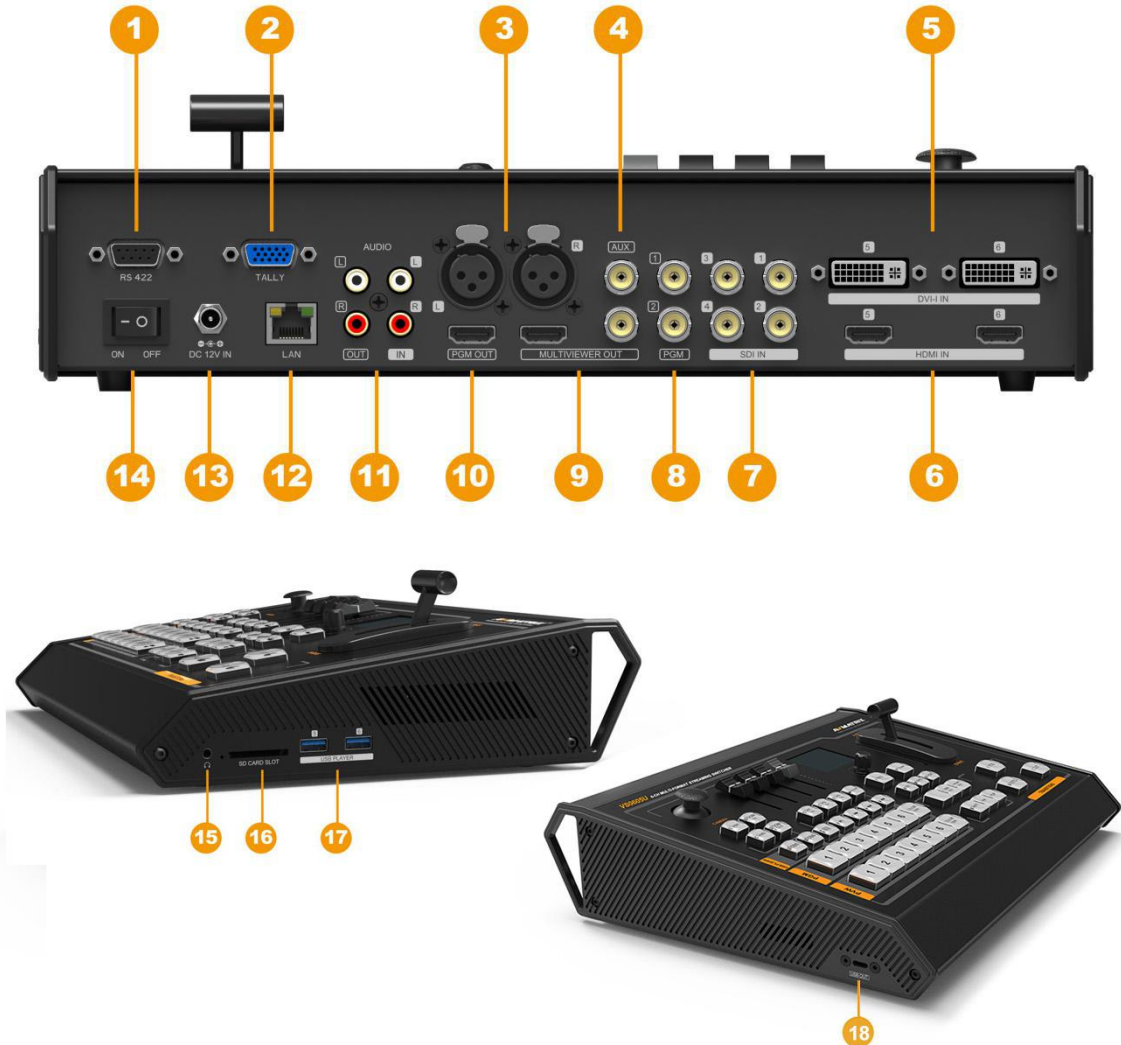

1	RS422 for camera remote control	10	1×HDMI PGM output
2	Tally port	11	RCA stereo audio(L/R) input/ output
3	XLR balanced audio(L/R) input	12	RJ45 For sync time & firmware upgrade
4	1×SDI AUX output (PVW/PGM)	13	DC port
5	2×DVI-I(VGA) input	14	Power switch
6	2×HDMI input	15	3.5mm earphone
7	4×SDI inputs	16	1×SD slot for record
8	2×SDI PGM outputs	17	2×USB media player
9	1×HDMI and 1×SDI Multiview Output	18	1×USB type-c(USB capture)

2.2 Specification

Inputs	Video Inputs	4×SDI, 2×HDMI/DVI-I/VGA/USB
	Bit Rate	270Mbps~3Gbps
	Impedance	75Ω (SDI/VGA), 100Ω (HDMI/DVI)
	SDI Input Format	1080p 60/59.94/50/30/29.97/25/24/23.98 1080psF 30/29.97/25/24/23.98 1080i 60/59.94/50 720p 60/59.94/50/30/29.97/25/24/23.98 625i 50 PAL, 525i 59.94 NTSC
	HDMI Input Format	4K 60/50/30, 2K 60/50/30 1080p 60/59.94/50/30/29.97/25/24/23.98/23.976 1080i 50/59.94/60 720p 60/59.94/50/30/29.97/25/24/23.98 576i 50, 576p 50, 480i 60, 480p 60
	DVI-I/ VGA Input Format	1920×1080 60Hz/ 1680×1050 60Hz/ 1600×1200 60Hz/ 1600×900 60Hz/ 1440×900 60Hz/ 1366×768 60Hz/ 1360×768 60Hz/ 1 280×1024 60Hz/ 1280×960 60Hz/ 1280×800 60Hz/ 1280×768 60Hz/ 1280×720 60Hz/ 1152×864 60Hz/ 1024×768 60Hz/ 640×480 60Hz
	SDI Video Rate	Auto detection, SD/HD/3G-SDI
	SDI Compliance	SMPTE 259M/ SMPTE 292M/ SMPTE 424M
	Bit Rate	270Mbps~3Gbps
	Color Space and Precision	SDI: YUV 4:2:2; HDMI: RGB 444; YUV 444; YUV 422
USB Output	USB interface	1×USB3.0 Type-C (USB3.1 Gen1, up to 200MB/s)
	Output Format	1920×1200, 1920×1080, 1680×1050, 1440×900, 1368×768, 1280×1024, 1280×960, 1280×800, 1280×720, 1024×768, 1024×576, 960×540, 856×480, 800×600, 768×576, 720×576, 720×480, 640×480,

		640×360
	Frame Rate	Up to 60fps
	Supports OS	Windows 7/8/10, Linux (Kernel version 2.6.38 and above), Mac OS (10.8 and above)
	Software compatibility	OBS studio, Skype, ZOOM, Teams, Google Meet, Youtube Live, QuikcTime Player, Face time, Wirecast, CAMTASIA, Ecamm.live, Twitch.tv, etc. (Windows) etc.
Outputs	PGM Outputs	2×HD/3G-SDI; 1×HDMI
	AUX Output	1×HD/3G-SDI
	PGM Output Format	1080p 50/60/30/25/24 1080i 50/60
	Multiview Output	1×3G-SDI; 1×HDMI Type A
	Multiview Output Format	1080p60
	Return Loss	>15dB 5MHz~3GHz
	Signal Amplitude	800mV±10% (SDI/HDMI/DVI-I/VGA)
	Impedance	SDI: 75Ω; HDMI: 100Ω
	DC Offset	0V±0.5V
Audio & Others	Audio Input	1×TRS(L/R), 50Ω 1×XLR(L/R), 50Ω
	Audio Output	1×TRS(L/R), 50Ω;
	LAN	RJ45
	SD Card Slot	1
	Power	DC 12V In, 1.7A
	Consumption	≤20W
	Operation Temperature	-20℃~60℃
	Storage Temperature	-30℃~70℃
	Operation Humidity	20%~70%RH

	Storage Humidity	0%~90%RH
	Dimension	322.4×19.7×57.8cm
	Weight	Net Weight: 1.9kg, Gross Weight: 3.7kg
	Warranty	2 Year Limited
Accessories	Accessories	1×Power Supply (DC12V 5A), 1× USB A-C cable, 1×RS422 Connector, 1×User Manual





3. Control Panel

3.1 Description

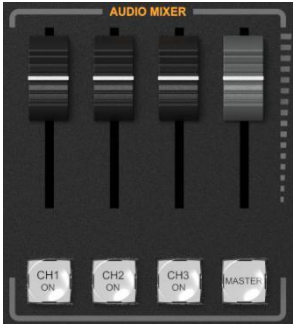

1	Camera Control
2	Audio Mixer
3	Menu Control and Display
4	T-bar Manual Transition
5	Auto, Cut, FTB
6	Transition Effects, MIX, WIPE, DP
7	Luma Key, Chroma Key, PIP, POP, SHIFT
8	USB Media Player Control
9	Program Row
10	Preview Row

3.2 Keyboard Button

<p>■ Camera Control</p> <p>CAM1 and CAM2 buttons are for Camera 1, Camera 2.</p> <p>ZOOM IN and ZOOM OUT to adjust the size of the picture.</p> <p>Press the button, the button LED will be turned on to indicate that the manual mode is enabled. Then the camera can be controlled via the Joystick.</p>	
<p>■ Audio Mixer</p> <p>CH1 ON / CH2 ON / CH3 ON buttons are for SDI1 / SDI2 / SDI3 / SDI4/ VIDEO5 / VIDEO6 / XLR / RCA / MIC audio source selection. Master for output the mixing audio to program.</p> <p>The audio faders are for adjusting the audio volume.</p>	
<p>■ Menu Control</p> <p>The LCD screen for showing the menu content and working status. The button for menu setting.</p> <p>Rotate the knob clockwise or counterclockwise to adjust the menu and increase and decrease the value.</p> <p>Press the button to select the menu option.</p>	
<p>■ T-Bar Manual Transition System</p> <p>User can do the transition between Preview and Program. The selected transition effects will work meantime. When the T-Bar has travelled from B-BUS to A-BUS the transition between sources is complete. The T-Bar has indicators next to it which light when the transition is complete.</p>	
<p>■ CUT & AUTO</p> <p>CUT performs a simple immediate switch between Program and Preview. The selected transition WIPE, MIX or FADE is not used.</p> <p>AUTO performs an automated switch between Program and Preview. The selected transition WIPE, MIX or FADE will also be used.</p>	

■ **PGM PVW Channel Selection**

PGM row is for selecting the signal source for program. Selected PGM button turns on the red LED.

PVW row is for selecting the signal source for preview. Selected PVW button will turn on the Green LED.

Color Bar button is for immediate switching the signal source of Program and preview to Color Bar Pattern.



■ **FTB**

Fade To Black, press this button it will fade the current video program source to black. The button will flash to indicate that it's active.

When press the button again it acts in reverse from complete black to the currently selected program video source, and button stop flashing.



■ **Transition Effects**

MIX: Pressing this button selects a basic A/B Dissolve for the next transition. When button LED turns on it is active.

WIPE: WIPE is a transition from one source to another and is achieved by replacing the current source by another source.

This WIPE effect is produced by then moving the T-Bar manually or by pressing the AUTO button.

FADE: It is a transition from one source to another with fade gradually transition effect.





■ **Luma Key**

Luma key consists of one video source containing the video image that will be stacked on top of the background.

All the black areas defined by the luminance in the video signal will be made transparent so that the background can be revealed underneath.

Therefore, the final composition does not retain any black from the graphic because all the black parts have been cut out of the image.

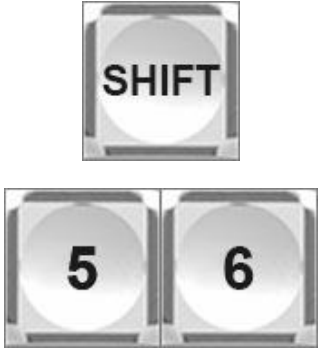
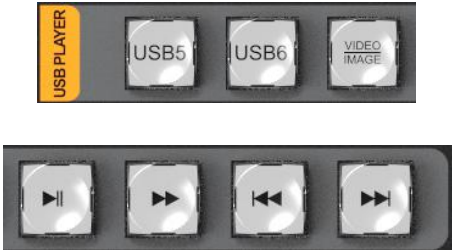

<p>■ Chroma Key</p> <p>In a chroma key two images are combined using a special technique and a color from one image is removed, revealing another image behind it. Chroma key is commonly used for weather broadcasts, where the meteorologist appears to be standing in front of a large map. In the studio the presenter is standing in front of a blue or green background. This technique is also referred to as color keying, color-separation overlay, green screen, or blue screen.</p>	
<p>■ PIP and POP</p> <p>PIP, Picture in Picture. The program is display on the full screen, and at same time the preview source will be displayed in the program window as an inset window. The size and location of the inset window can be adjusted from the menu.</p> <p>POP, Picture outside Picture. This is the same function as PIP only this allows you to see the program source and preview source side by side.</p>	
<p>■ SHIFT</p> <p>The SHIFT button is an alternate function key. When press the SHIFT button with 5/6 buttons from PVW row, the signal source of the channel 5/6 will be selected from DVI / VGA / USB.</p> <p>USB signal source comes from two USB media players.</p>	
<p>■ USB Media Player Control</p> <p>The video switcher has two USB ports for playing the USB media, including video and picture.</p> <p>Press USB5 or USB6 button to select the one which you want to control. The VD/PIC button is for switching the media format between video and picture.</p> <p>There are Play / Pause, Fast Forward, BACK and NEXT buttons to control the media source from USB flash drive.</p> <p>The Fast Forward support max 32 times speed to play the video. When it is playing the video, the BACK will be active after double pressing. If you press 1 time BACK button the video will play from the beginning.</p>	

4. Operation Instrubtion

4.1 Multiview Output Layout

1) PGM and PVW as Preview and Program displayed as following image. The level meter of PGM audio is shown only in multiview. SDI/HDMI PGM out is without any overlays.



2) The following 6 windows come from the 6 input signals. The signal source of window 5 and 6 can be selected from HDMI, DVI, VGA, USB.



3) The lower right corner displays the menu and status information. The CH1, CH2, CH3 are the channel selection of the 3 audio sources for audio mixer. There is a real-time Digital clock / Analog clock displayed beside the menu.

4.2 T-Bar Calibration

The T-Bar of the video switcher may happen to misalignment, when the origin of the coordinates offset the T-Bar calibration is necessary before using.

1) Power off the video switcher, and then press and hold button 1 and 2 of PVW at same time. Hold the buttons until all calibration complete.



2) Turn on the video switcher, then the LED indicators of T-Bar will be turn on from bottom to top.

3) Adjust the T-Bar to A-BUS or B-BUS until all LED indicators turn on. Below image is an example of the LED indicators status when switching the T-Bar from B-BUS to A-BUS.

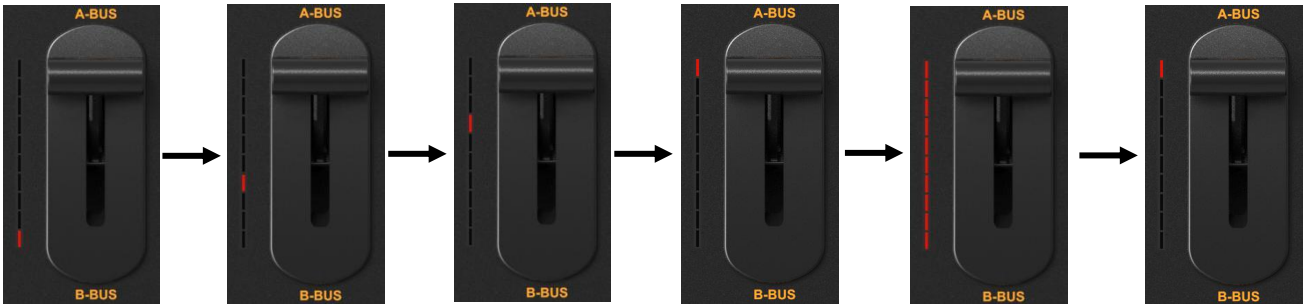

4) Then the T-Bar calibration is finished, and release the button 1 and 2.

4.3 PGM & PVW Switching

4.3.1 PGM & PVW Channel Selection

Below 1-6 buttons from PGM and PVW are corresponding with the 6 windows in the below of the multiview layout. The selected button from PGM turns on to red LED, and the selected button from PVW turns on to green LED.

The default sources of PGM and PVW are SDI 2 and SDI 1 when turn on the video switch. When operating the AUTO or T-Bar transition, both LED indicators are turning red.



The selected PGM source will be circled in red border, while the selected PVW source will be circled in green border.



4.3.2 Transition Control

1) Transition without Effects

CUT performs a simple immediate switch between Preview and Program views. This is no delay seamless switching and the selected transition effect WIPE, MIX or FADE is not used.

2) Transition with Effects

AUTO performs an automated switch between Preview & Program views. The speed of the transition is set by the menu. The selected transition WIPE, MIX or FADE will also be used. T-Bar transition effect performs same as AUTO, but speed depends on the speed of the manual switch.

4.3.3 FTB (Fade to Black)

Press FTB button it will fade the current video Program source to black. The button will flash to indicate that it's active. When press the button again it acts in reverse from complete black to the currently selected Program video source, and button stop flashing. FTB is usually used for emergency condition.



Note: When the PGM window display black and keep black even after transition, please check if the FTB button flashing or not. If it is flashing press the button again to stop black.

4.3.4 Source Selection of Channel 5 and Channel 6

Hold the button SHIFT and press button 5 / button 6 to cyclic switch the video source among HDMI, DVI, VGA and USB. The default format is HDMI. The switcher saves the settings when turn off the switcher.

4.3.5 USB Media Player

1) USB Media Player Setup

Plug in the USB flash drive into the USB port in the side panel as below image:



Setup the video source of channel 5 or 6 to USB (refer to 4.3.4), then manage the USB media player from the control panel. Press the button USB5 or USB6 which one you want to control. The USB media player can play video or picture from USB flash drive. Switching the source of media file between video and picture by pressing the button VD/PIC. All settings of the USB media player will be saved into the switcher. And when you restart it the switcher will default play video or picture you set at last time.



There are Play/ Pause, Fast Forward, BACK and NEXT buttons to control the media source from USB flash drive. The Fast Forward supports max 32 times speed to play the video. When it is playing the video, the BACK will be active after double pressing. If you press BACK button one the video will play from the beginning.

2) Video Format Supporting

FLV	MPEG4(Divx), AVC(H264), FLV1	MP4	MPEG4(Divx), MPEG4(Xvid), AVC(H264), HEVC(H265)
AVI	MPEG4(Divx), MPEG4(Xvid), AVC(H264), HEVC(H265), MPEG2	MKV	MPEG4(Divx), MPEG4(Xvid), AVC(H264), HEVC(H265)
MPG	MPEG1	MOV	MPEG4(Divx), AVC(H264), HEVC(H265)

3) Image format supporting: BMP, JPEG, PNG.

4.4 Transition Effects

4.4.1 MIX Transition

Press the MIX button to select a basic A/B Dissolve for the next transition. When button LED turns on it is active. Then use T-Bar or AUTO to operate the transition. And there are 3 different speed rates for choice from the menu. The MIX transition effect as below



4.4.2 WIPE Transition

WIPE is a transition from one source to another and is achieved by replacing the current source by another source. Press the WIPE button and the LED turns on then it is active. There are total 8 WIPE selections wiping start from different directions, including Left-Up, Up, Right-Up, Left, Right, Left-Down, Down, and Right-Down. And there are 3 different speed rates for choice from the menu.

For example, if choosing Right-Up from the menu, then use T-Bar or AUTO to operate the transition, the WIPE effect as following:



4.4.3 FADE Transition

Fade is a transition from one source to another with fade gradually transition effect. Press the FADE button and use T-Bar or AUTO to operate the FADE transition. And there are 3 different speed rates for choice from the menu.

Main Menu	Secondary Menu	Option	Default
Effect	Effect	MIX/WIPE/FADE	MIX
	Rate	0/1/2	0
	Wipe	Left-Up/ Up/ Right-Up/ Left/ Right/ Left-Down/ Down/ Right-Down	Left-Up
	Exit		

4.5 PIP and POP

When the T-Bar located at B-BUS to active the PIP/POP, there will be a small image display on the top left corner of the PVW window as following image:



Press button 1-6 from PVW row to switch the video source of PIP/POP. When press PIP/POP button the menu will get into an interface as below image. The window size, position and border of PIP can be set from menu by the knob.

Main Menu	Secondary Menu	Option	Default
PIP	Window	1	1
	H Position	0	0
	V Position	0	0
	Size	Small/ Medium /Large	Small
	Border Enable	On/ Off	On
	Border Width	2~7	2
	Border Color	White/ Red/ Blue/ Green	White
	Exit		
POP	Window	1~2	1
	H Position	0	0
	V Position	0	270
	Size		
	Border Enable	On/Off	On
	Border Width	2~7	2
	Border Color	White/ Red/ Blue/ Green	White
	Exit		

4.6 Chroma Key

Turn on the Chroma Key, a color from the key source will be removed, revealing another background image behind it. Chroma Key is usually used for virtual studio, such as weather broadcasts, where the meteorologist appears to be standing in front of a large map. In the studio the presenter is standing in front of a blue or green background.

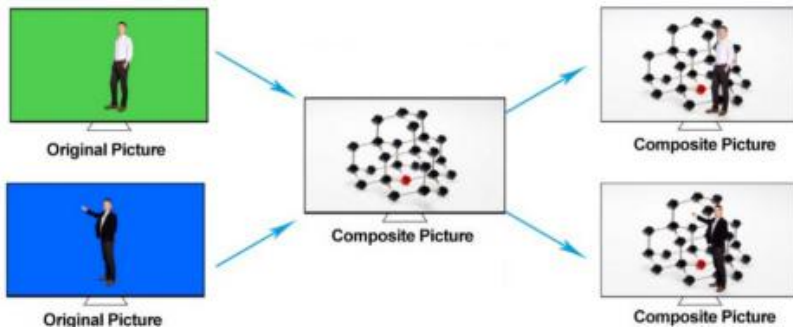

Switching a video with blue or green background to PVW window, and turn on the Chroma Key. Then go to the Key menu to configure the value level of color gamut of the Chroma Key. And the KEY background can be switch between Green and Blue. After finish the configuration, using CUT, AUTO, or T-Bar to switch the image to overlay in the PGM window.

Main Menu	Secondary Menu	Option	Default
CHROMA KEY	KEY	ChromaKey	None
	Background	Blue/Green	Blue
	Level	0-64	16
	Exit		

4.7 Luma Key

When turn on the Luma Key, all the black areas defined by the luminance in the video signal will be made transparent so that the background can be revealed underneath. Therefore, the final composition does not retain any black from the graphic because all the black parts have been cut out of the image. This function is often used for subtitle overlay of virtual studio.

Switching a video with black background and white font subtitle to PVW and turn on the Luma Key. Using CUT, AUTO, or T-Bar to switch the subtitle to overlay in the PGM window.

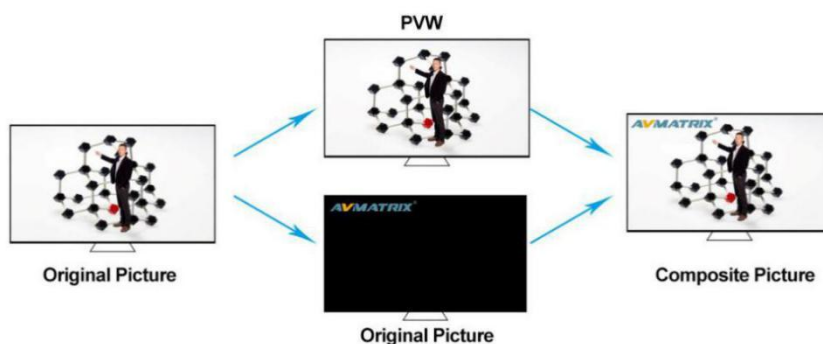

4.8 USB3.0 Live Streaming

The USB3.0 streaming output transmits the PGM as an uncompressed Video and Audio signal. The USB3.0 streaming output is based on UVC (USB video class) and UAC (USB audio class) standard. No additional drivers need be installed. After installation in operating system, the relevant video and audio devices will be added in the Windows Device Manager. There will appear two new devices:

- Under Imaging Devices: AVMATRIX USB Capture Video
- Under Audio inputs and outputs: AVMATRIX USB Capture Audio

Use a third party Video Media Player like PotPlayer, OBS, Windows Media Player to play and store the captured video content.

5. PTZ Camera Remote Control

5.1 Camera Setting

Two PTZ cameras can be control through the RS-422 port of the video switcher. You can pan, tilt, zoom two cameras separately by using a joystick and buttons.

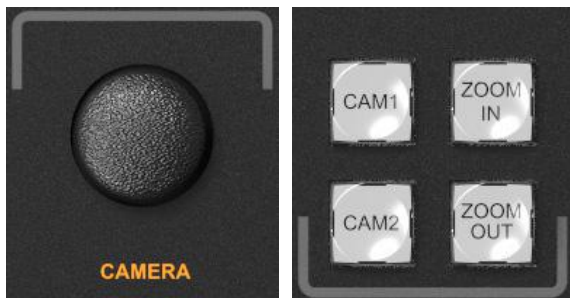

Press button CAM1 or CAM2 to select the one you want to control, and the button will be turn on which indicates the camera ins under control. And the LCD menu screen will show the configuration options, you can set the PTZ camera address, protocol and baud rate accordingly. ZOOM IN and ZOOM OUT buttons to focus the camera lens.

Main Menu	Secondary Menu	Option	Default
CAMERA	Addr	1-16	1
	Protocol	PELCO D/VISCA	PELCO D
	Rate	300/600/1200/2400/4800/9600/14400 /19200/38400/57600/115200	2400
	Exit		

5.2 RS-422/RS-485 Interface Define

The video switcher is equipped with a 9-pin DB9 interface for camera control. The PIN definition are defined as below. The PIN not defined here is reserved, with no function.

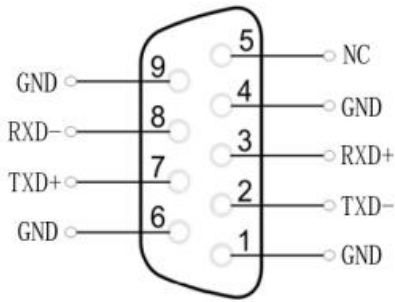

Pin	2	7	3	8	6	1、4、5、9
RS-422	TXD- (B-)	TXD+ (A+)	RXD+ (A+)	RXD- (B-)	GND	NC
RS-485	DATA- (B-)	DATA+ (A+)	-	-	GND	NC

Note:

TXD+ is connected to RXD+ of PTZ, TXD- is connected to RXD- of PTZ.

VS0605U does not process the PTZ return instruction. It can be used without connecting RXD + and RXD- of VS0605.

6. Menu Settings

6.1 Status Menu

The status menu includes Audio settings, and AUX and PGM out settings. All the settings will be saved when you restart the switcher.

Main Menu	Secondary Menu	Option	Default
STATUS	CH1	IN1/IN2/IN3/IN4/IN5/IN6/XLR_IN/RCA_IN	IN1
	CH2	IN1/IN2/IN3/IN4/IN5/IN6/XLR_IN/RCA_IN	IN2
	CH3	IN1/IN2/IN3/IN4/IN5/IN6/XLR_IN/RCA_IN	IN3
	Earphone	IN1/IN2/IN3/IN4/IN5/IN6/PGM/XLR_IN/RCA_IN	PGM
	AUX	PGM/PVW	PGM
	Audio Mode	Mixing/Follow	Mixing
	PGM Out	1080P30/1080P25/1080P24/1080P60/1080P50/ 1080I60/1080I50	1080P30

6.1.1 Audio Settings

This video switcher has a pair of XLR (L/R) audio and a pair of RCA (L/R) analog audio inputs. There are audio mixing mode and follow mode for selection.

1) Mixing Mode. Set the audio mode to Mixing from menu. It can mix total 3 audios. Select the audio source of CH1, CH2, CH3 from menu, and there are IN1/ IN2/ IN3/ IN4/ IN5/ IN6/XLR_IN/ RCA_IN for choice. And press CH1/ CH2/ CH3 button to enable corresponding audio channel. Push the 3 white color

faders to adjust each audio volume, and push the red color master fader to control the master audio volume.

2) Follow Mode. Set the audio mode to Follow from menu. Then the audio is coming from the embedded audio of Program video source. Press Master button to enable the Follow mode audio. Adjust the master fader to control the audio volume.

3) Earphone. Set the earphone audio source from IN1/IN2/IN3/IN4/IN5/IN6/PGM/XLR_IN/RAC_IN. The earphone port is a 3.5mm port.

6.1.2 Output Format Setting

1) PGM Out. PGM output format can be set by the knob from status menu. There are formats 1080P50/60/30/25/24Hz, 1080I50/60Hz selectable for SDI/ HDMI PGM. The AUX out format and recording PGM resolution are same to PGM out format.

2) AUX. AUX out can be defined as PVW or PGM out. You can quickly select the auxiliary output between PVW and PGM via Menu knob.

3) Multiview Out. The output format of multiview is fixed at 1080p60hz for both multiview output.

6.2 Main Menu

If STATUS menu is unselected, press the MENU button to go to main menu directly. If the menu is selected in the secondary menu, rotate anticlockwise the MENU button to exit the menu and then press the MENU button to go to the main menu.

Main Menu	Secondary Menu	Option	Default
System Settings	Language	English/中文	English
	Brightness	10~100	50
	Status	Always/Dim/off	Always
	Backlit Time	5~60	50
	Clock	Analog/Digital	Analog
	Reset		
	Return		
Network Settings	IP Acquisition	Static/Dynamic	Dynamic
	IP		192.168.1.215
	Netmask		255.255.255.0
	Gateway		192.168.1.1
	Save		
	Return		
Record	Encoding	VBR	VBR

	Level	Low/Medium/High/Ultra High	Medium
	Return		
TSL Setting	TSL Setting	Off/On	Off
	Baud		38400
	Return		
Device Info	Version		22-11-15-2c-10-10-06-6b-11-00
	Return		
Exit			

6.2.1 System Settings

1) Language. Access to system settings from the menu to switch the system language between English and Chinese.

2) Clock and Setting. Access to system settings from the menu to switch the real-time clock shown in Analog or Digital. The time of clock can be set through a PC software through the Ethernet.

Connect video switcher to a PC and download a time control software from AVMATRIX official website www.avmatrix.net/download/ Open the software and click Scan button to search and connect the device, then the clock time will be changed to same time to the PC's time.



6.2.2 Network Settings

1) IP Setting. There are two ways to acquire the IP: Dynamic (IP configured by router) and Static (set IP freely by yourself). Select the method you need by knob menu. The default setting is Dynamic.

Dynamic: Connecting the video switcher with a router with DHCP features, then it will auto obtain an IP address automatically. Make sure that the video switcher and PC are in the same local area network.

Static: Select static IP when the PC is without DHCP. Connect the video switcher with PC via network cable, set the PC's IP address to the same IP range as video switcher (the video switcher's default IP address 192.168.1.215), or set the video switcher's IP address to the same IP range as PC's IP address.

2) Netmask. Set the Netmask. The default setting is 255.255.255.0.

3) Gateway. Set the Gateway according to the IP address. Save configuration when network setting finish

6.2.3 Record Settings

1) Basic Specification

Record Video Source	PGM
---------------------	-----

Record Storage	SD Card (class 10)
SD Card Format	Max 512GB (file system format exFAT or FAT32)
Record Video Format	H.264 (mp4)
Record Video Resolution	1080p 60/50/30/25/24hz, 1080i 60/50hz

2) SD Card Install and Uninstall

Install: Format SD card to exFAT or FAT32. Install Plug and press the SD card into the slot from the side of video switcher. Wait 3 sec, the LED indicator beside it will turn on.

Uninstall: Press the card to take it out. Use a card reader to play or copy the video files to a computer.

3) Recording Control

Press REC button start recording. Meantime, the button indicator turns on. During recording, press Pause button the recording pause, and press Pause button again recording continue. Press REC button again recording stops and save the video files to SD card.

The recording status shown beside the menu, including information of REC mark, recording time, SD card available storage. Record video resolution is same to PGM output format.



Note:

1. The record file will be saved to SD card only after pressing the REC button to stop recording. Otherwise, the record file might be corruption.
2. In case the switcher is power off during record, the record file might be corruption.
3. If you want to change the PGM output resolution during recording, please stop recording and save the file first, then new record video will be in new resolution. Otherwise, the record video files in SD card will be abnormal.

4) Recording Format and Quality

Entering into the recording settings in main menu, the default encoding format of the recording is VBR.

There are 4 level of video record quality for choice, Ultra High, High, Medium and Low.

6.2.4 TSL Settings

For the tally function by RS422.

6.2.5 Tally Port Define

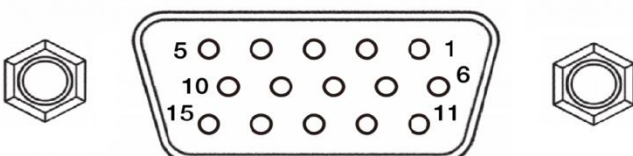

PIN	Definition	PIN	Definition
11	PGM-IN1	6	PVW-IN1
12	PGM-IN2	7	PVW-IN2
13	PGM-IN3	8	PVW-IN3
14	PGM-IN4	9	PVW-IN4
15	PGM-IN5	10	PVW-IN5
3	PGM-IN6	4	PVW-IN6
5	GND		

6.2.6 Device Info

The firmware version number can be checked from the Device Info in Main Menu. Such as”
 xx-xx-xx-xx-xx-xx-xx-xx-xx”